

800X480 DOTS - IPS INCL METAL FRAME FOR MOUNTING



Dimension 124x78.5x9.1mm

FEATURES

- 5" TFT DISPLAY WITH 800x480x3 DOTS
- IPS TECHNOLOGY FOR WIDEST VIEWING ANGLE >160°
- 800x480x3 DOTS
- NO COLOR SHIFT OVER VIEWING ANGLE
- SUNLIGHT READABLE WITH 1000cd/m²
- EXTREME WIDE T_{OP}. -30..+80°C
- 24 BIT RGB INTERFACE
- SINGLE SUPPLY 3.3V
- MOUNTING TO PCB VIA BLACK METAL FRAME

ORDERING CODE

5" TFT DISPLAY 800X480 IPS, 1000cd/m²

EA W800X-50AILW

ACCESSORIES

CAPACITIVE TOUCH PANEL
RESISTIVE TOUCH PANEL

EA TOUCH800-50C1
EA TOUCH800-50R1

ZIFF CONNECTOR, BOTTOM CONTACT SUITING FOR DISPLAY
ZIFF CONNECTOR, TOP CONTACT SUITING FOR DISPLAY

EA WF050-40S
EA WF050-40ST

ZIFF CONNECTOR, BOTTOM CONTACT SUITING FOR PCAP
ZIFF CONNECTOR, BOTTOM CONTACT SUITING FOR RESISTIVE TOUCH

EA WF100-06S
EA WF100-04S

CONTENTS

Features	1
Ordering Code	1
Accessories	1
Contents	2
Summary	3
General Specifications	4
Absolute Maximum Ratings	5
Electrical Characteristics	6
Typical Operation Conditions	6
Backlight Driving Conditions	6
Communication Interface	7
SYNC-DE Mode	7
Parallel 24-bit RGB Input Timing Table	8
System Bus Timing for RGB Interface	8
Power ON/OFF Sequence	10
Optical Characteristics	11
Interface	13
LCM PIN Definition	13
Reliability	14
Contour Drawing	15
Capacitive touch	16
Resistive touch	17

SUMMARY

EA W800X-50AILW is a color active matrix thin film transistor (TFT) liquid crystal display (LCD) that uses amorphous silicon TFT as a switching device. It's an IPS technology which provides an extreme wide viewing angle all around. There's no more color shift or inversion effect. Together with the bright backlight it is definitely readable und all light conditions including direct sunlight.

This TFT LCD has a 5.0 inch diagonally measured active display area with 800x480 (800 horizontal by 480 vertical pixel) resolution.

A black metal frame enables easy mounting direct to pcb or any other base board with 1.6mm thickness.

GENERAL SPECIFICATIONS

Item	Dimension	Unit
Size	5.0	inch
Dot Matrix	800× 3(RGB) × 480	dots
Module dimension	124.0(W) ×78.5(H) ×9.1	mm
Active area	108(W) ×64.8 (H)	mm
Dot pitch	0.135(W) ×0.135(H)	mm
LCD type	TFT, Normally Black, Transmissive - IPS	
View Direction	80/80/80/80	
Aspect Ratio	16:9	
Driver IC	ST7262 or equivalent	
Interface	24 bit R.G.B.	
Backlight Type	LED white*	
With /Without TP	Without TP	
Surface	Anti-Glare	

*Color tone slight changed by temperature and driving voltage.

ABSOLUTE MAXIMUM RATINGS

Item	Symbol	Min	Typ	Max	Unit
Operating Temperature	TOP	-30	—	+80	°C
Storage Temperature	TST	-30	—	+80	°C

Note: Device is subject to be damaged permanently if stresses beyond those absolute maximum ratings listed above

1. Temp. $\leq 60^{\circ}\text{C}$, 90% RH MAX. Temp. $> 60^{\circ}\text{C}$, Absolute humidity shall be less than 90% RH at 60°C

ELECTRICAL CHARACTERISTICS

TYPICAL OPERATION CONDITIONS

Item	Symbol	Values			Unit	Remark
		Min.	Typ.	Max.		
Power voltage	VCC	3.0	3.3	3.6	V	
Current for Driver(Black)	ICC	-	65	97.5	mA	VCC=3.3V
Input logic high voltage	VIH	0.7 VCC	-	VCC	V	Note 1
Input logic low voltage	VIL	0	-	0.3 VCC		

Note1: CLK,DE,HSYNC,VSYNC,R0~R7, G0~7, B0~7.

BACKLIGHT DRIVING CONDITIONS

Item	Symbol	Values			Unit	Remark
		Min.	Typ.	Max.		
Voltage for LED backlight	VLED	27.5	30	33	V	Note 1
Current for LED backlight	ILED	--	40	--	mA	
LED life time	-	--	50,000	-	Hr	Note 2

Note 1: The LED Supply Voltage is defined by the number of LED at Ta=25°C and IL=20ma/pcs.

Note 2: The "LED life time" is defined as the module brightness decrease to 50% Original brightness at Ta=25°C and ILED=20mA/pcs. The LED lifetime could be decreased if operating IL is larger than 25mA/pcs.

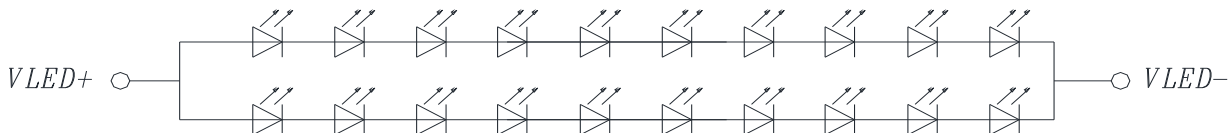

CIRCUIT DIAGRAM(LED 2*10=20 DIES)

COMMUNICATION INTERFACE

SYNC-DE MODE

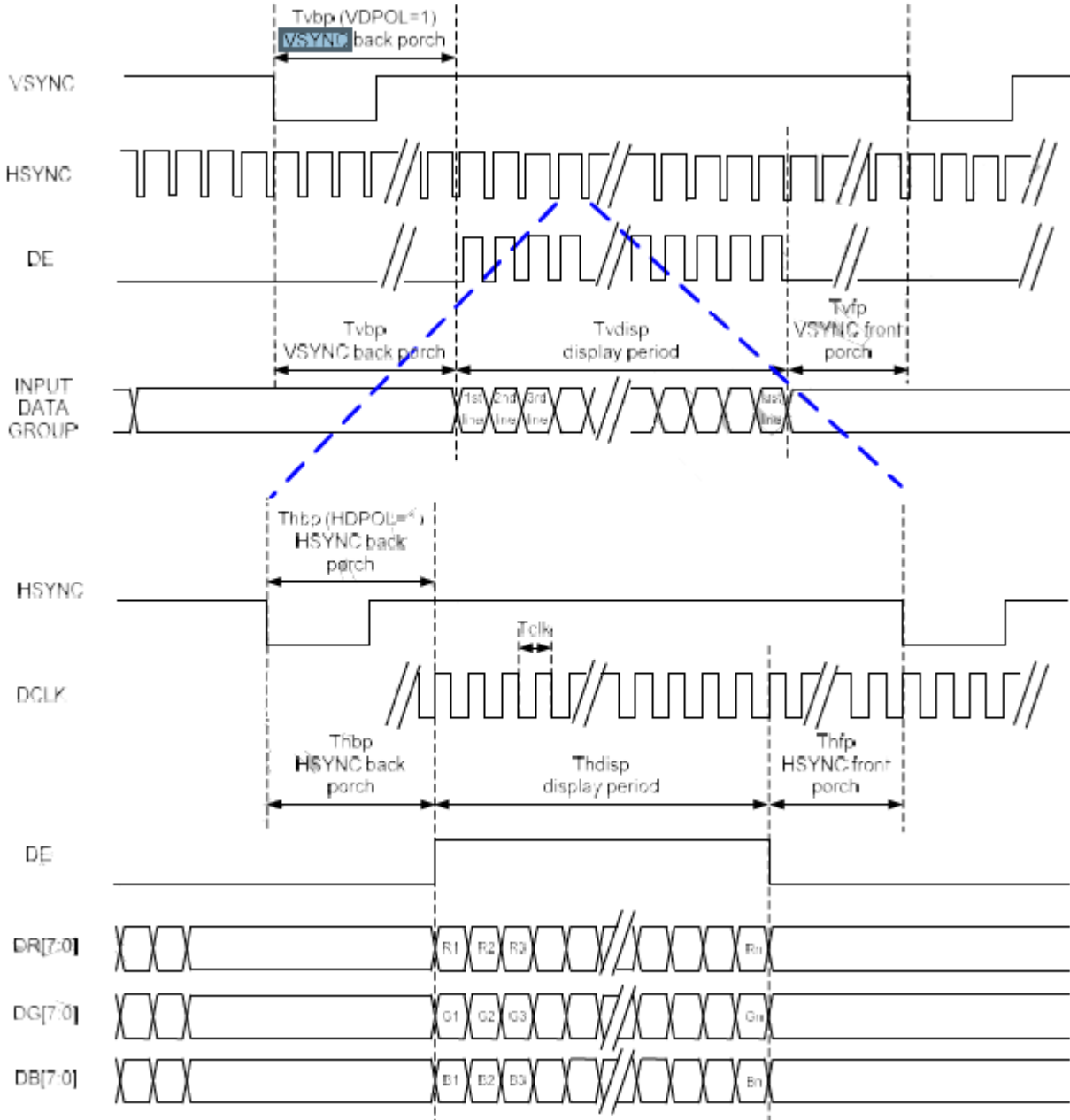

PARALLEL 24-BIT RGB INPUT TIMING TABLE

Parallel 24-bit RGB Input Timing (VCC= 3.3V, GND= 0V, TA=25°C)

Parallel 24-bit RGB Interface Timing Table						
Item	Symbol	Min.	Typ.	Max.	Unit	Remark
DCLK Frequency	Fclk	23	25	27	MHz	
HSYNC	Period Time	Th	-	816	896	DCLK
	Display Period	Thdisp	800		DCLK	
	Back Porch	Thbp	-	8	48	DCLK
	Front Porch	Thfp	-	8	48	DCLK
	Pulse Width	Thw	-	4	8	DCLK
VSYNC	Period Time	Tv	-	496	504	HSYNC
	Display Period	Tvdisp	480		HSYNC	
	Back Porch	Tvbp	-	8	12	HSYNC
	Front Porch	Tvfp	-	8	12	HSYNC
	Pulse Width	Tvw	-	4	8	HSYNC

SYSTEM BUS TIMING FOR RGB INTERFACE

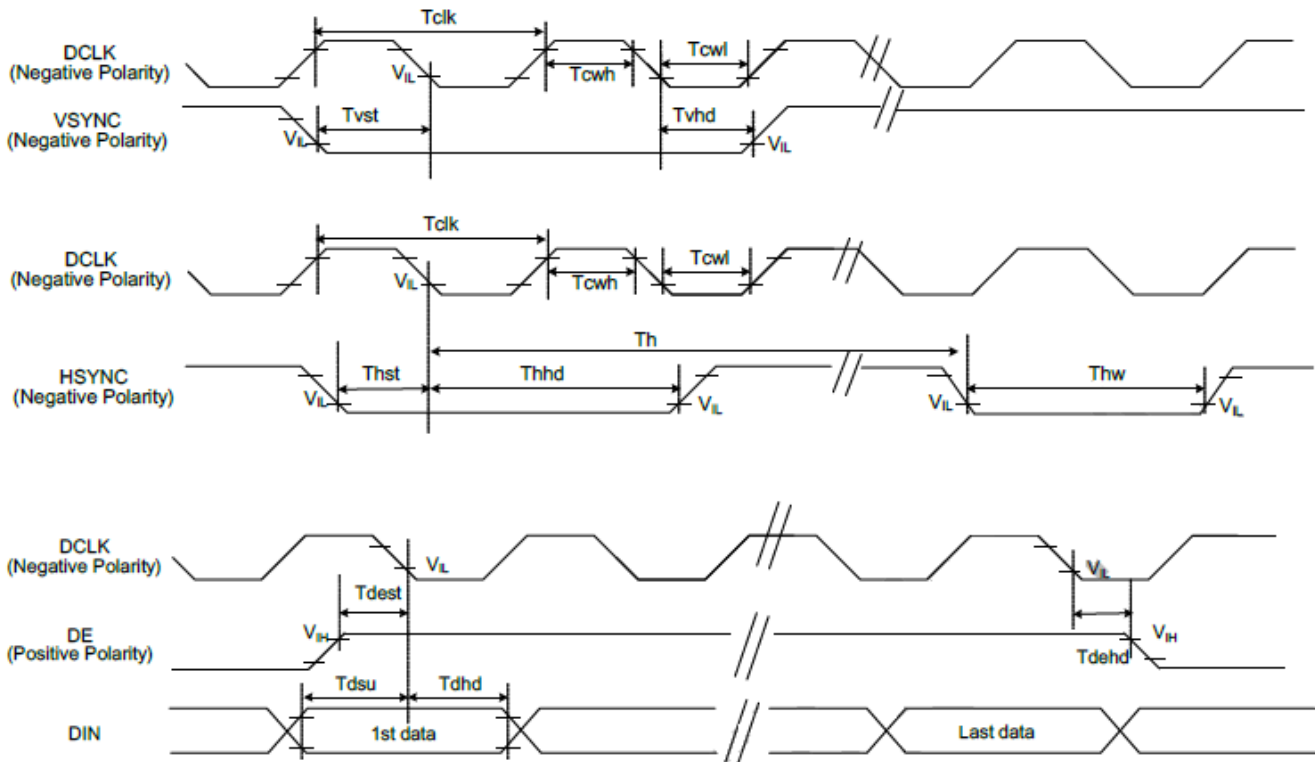

Item	Symbol	Min.	Typ.	Max.	Unit	Conditions
CLK Pulse Duty	Tcw	40	50	60	%	
HSYNC Width	Thw	2	-	-	DCLK	
HSYNC Period	Th	55	60	65	us	
VSYNC Setup Time	Tvst	10	-	-	ns	
VSYNC Hold Time	Tvhd	10	-	-	ns	
HSYNC Setup Time	Thst	10	-	-	ns	
HSYNC Hold Time	Thhd	10	-	-	ns	
Data Setup Time	Tdsu	10	-	-	ns	
Data Hold Time	Tdhd	10	-	-	ns	
DE Setup Time	Tdest	10	-	-	ns	
DE Hold Time	Tdehd	10	-	-	ns	

POWER ON/OFF SEQUENCE

Power-On Sequence

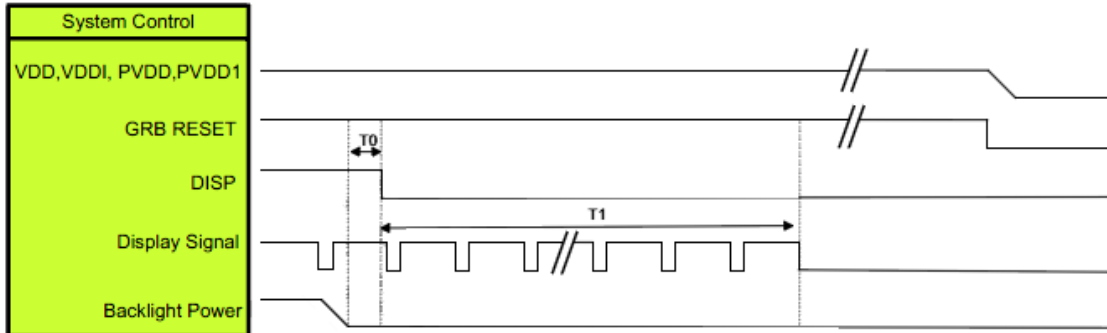

Symbol	Description	Min. Time	Unit
T0	Backlight Power off to DISP="Low"	5	ms
T1	DISP="Low" to IC internal voltage discharge complete	100	ms

Note: RGB interface Display signal: DCLK; VSYNC; HSYNC; DE; DR[7:0]; DG[7:0]; DB[7:0]

Power-On Sequence

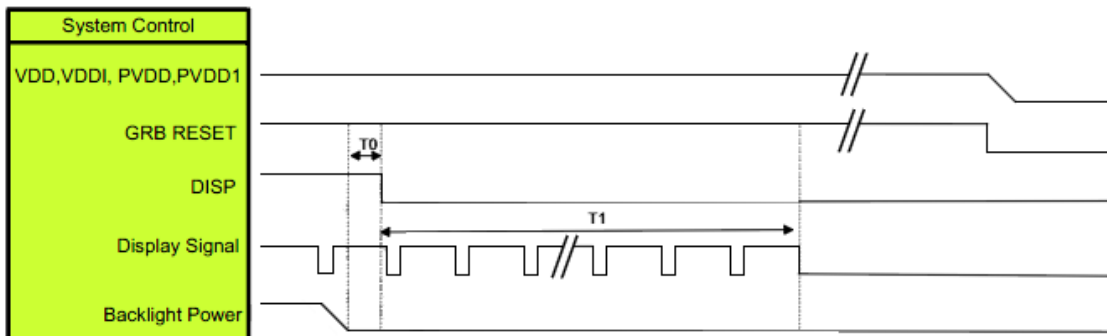

Symbol	Description	Min. Time	Unit
T0	Backlight Power off to DISP="Low"	5	ms
T1	DISP="Low" to IC internal voltage discharge complete	100	ms

Note: RGB interface Display signal: DCLK; VSYNC; HSYNC; DE; DR[7:0]; DG[7:0]; DB[7:0]

OPTICAL CHARACTERISTICS

Item	Symbol	Condition.	Min	Typ.	Max.	Unit	Remark	
Response time	Tr+Tf	$\theta=0^\circ$ 、 $\Phi=0^\circ$	-	30	40	.ms	Note 3	
Contrast ratio	CR	At optimized viewing angle	800	1000	-	-	Note 4	
Color Chromaticity	White	Wx	$\theta=0^\circ$ 、 $\Phi=0$	0.27	0.32	0.37	Note 2,6,7	
		Wy		0.295	0.345	0.395		
Viewing angle	Hor.	Θ_R	$CR \geq 10$	70	80	-	Deg.	Note 1
		Θ_L		70	80	-		
	Ver.	Φ_T		70	80	-		
		Φ_B		70	80	-		
Brightness	-	-	850	1000	-	cd/m ²	Center of display	
Uniformity	(U)	-	75	-	-	%	Note5	

Ta=25±2°C

Note 1: Definition of viewing angle range

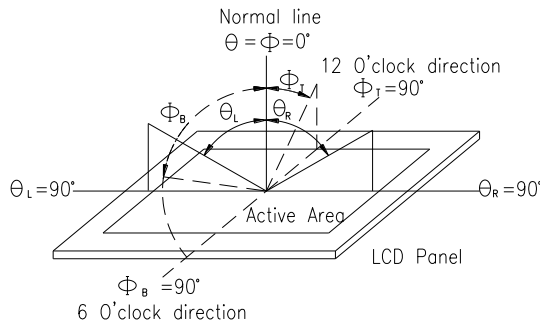

Fig. 8.1. Definition of viewing angle

Note 2: Test equipment setup:

After stabilizing and leaving the panel alone at a driven temperature for 10 minutes, the measurement should be executed. Measurement should be executed in a stable, windless, and dark room. Optical specifications are measured by Topcon BM-7or BM-5 luminance meter 1.0° field of view at a distance of 50cm and normal direction.

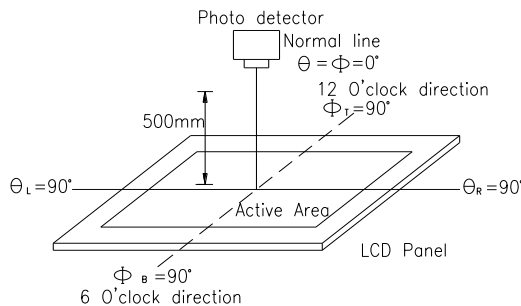
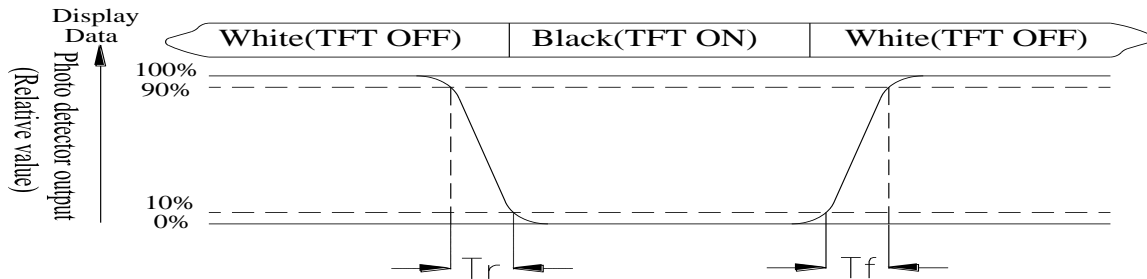

Fig. 8.2. Optical measurement system setup

Note 3: Definition of Response time:

The response time is defined as the LCD optical switching time interval between "White" state and "Black" state. Rise time, T_r , is the time between photo detector output intensity changed from 90% to 10%. And fall time, T_f , is the time between photo detector output intensity changed from 10% to 90%



Note 4: Definition of contrast ratio:

The contrast ratio is defined as the following expression.

$$\text{Contrast ratio (CR)} = \frac{\text{Luminance measured when LCD on the "White" state}}{\text{Luminance measured when LCD on the "Black" state}}$$

Note 5: Definition of Luminance Uniformity

Active area is divided into 9 measuring areas (reference the picture in below). Every measuring point is placed at the center of each measuring area.

$$\text{Luminance Uniformity (U)} = \text{Lmin/Lmax} \times 100\%$$

L = Active area length

W = Active area width

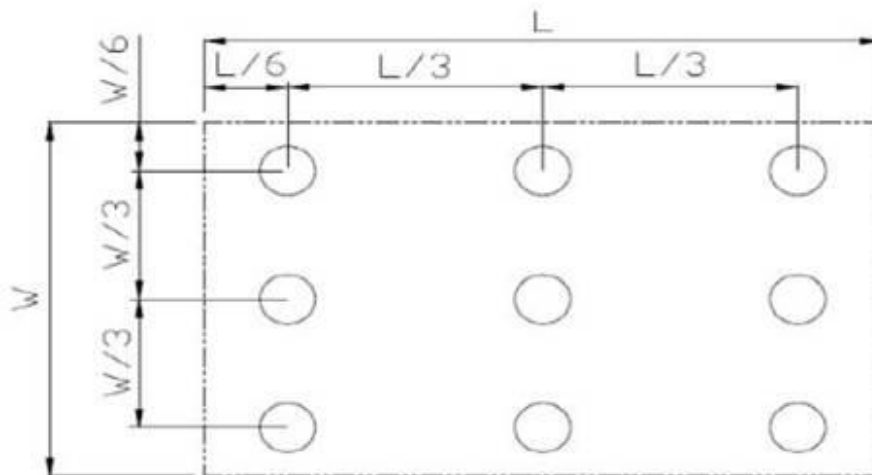

Fig8.3. . Definition of uniformity

Note 6: Definition of color chromaticity (CIE 1931)

Color coordinates measured at the center point of LCD

Note 7: Measured at the center area of the panel when all the input terminals of LCD panel are electrically opened.

INTERFACE

LCM PIN DEFINITION

Pin	Symbol	Function	Remark
1	VLED-	Power for LED backlight (Cathode)	
2	VLED+	Power for LED backlight (Anode)	
3	NC	No connection	
4	VCC	Power voltage	
5	R0	Red data (LSB)	
6	R1	Red data	
7	R2	Red data	
8	R3	Red data	
9	R4	Red data	
10	R5	Red data	
11	R6	Red data	
12	R7	Red data(MSB)	
13	G0	Green data(LSB)	
14	G1	Green data	
15	G2	Green data	
16	G3	Green data	
17	G4	Green data	
18	G5	Green data	
19	G6	Green data	
20	G7	Green data(MSB)	
21	B0	Blue data(LSB)	
22	B1	Blue data	
23	B2	Blue data	
24	B3	Blue data	
25	B4	Blue data	
26	B5	Blue data	
27	B6	Blue data	
28	B7	Blue data(MSB)	
29	GND	Power Ground	
30	CLK	Sample clock	
31	DISP	Display on/off	
32	HSYNC	Horizontal sync signal applied to the RGB interface, default is negative polarity.	
33	VSYNC	Vertical sync signal applied to the RGB interface, default is negative polarity.	
34	DE	Data input enable	
35	NC	No connection	
36	NC	No connection	
37	NC	No connection	
38	NC	No connection	
39	NC	No connection	
40	NC	No connection	

RELIABILITY

Content of Reliability Test (Super Wide temperature, -30°C~80°C)

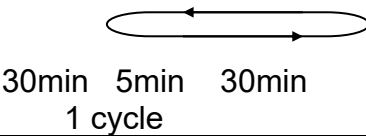
Environmental Test			
Test Item	Content of Test	Test Condition	Note
High Temperature storage	Endurance test applying the high storage temperature for a long time.	80°C 200hrs	2
Low Temperature storage	Endurance test applying the low storage temperature for a long time.	-30°C 200hrs	1,2
High Temperature Operation	Endurance test applying the electric stress (Voltage & Current) and the thermal stress to the element for a long time.	80°C 200hrs	—
Low Temperature Operation	Endurance test applying the electric stress under low temperature for a long time.	-30°C 200hrs	1
High Temperature/ Humidity storage	The module should be allowed to stand at 60°C,90%RH max	60°C,90%RH 96hrs	1,2
Thermal shock resistance	The sample should be allowed stand the following 10 cycles of operation <div style="text-align: center;"> <p>-30°C 25°C 80°C</p>  <p>30min 5min 30min 1 cycle</p> </div>	-30°C/80°C 10 cycles	—
Vibration test	Endurance test applying the vibration during transportation and using.	Total fixed amplitude : 1.5mm Vibration Frequency : 10~55Hz One cycle 60 seconds to 3 directions of X,Y,Z for Each 15 minutes	3
Static electricity test	Endurance test applying the electric stress to the terminal.	VS=±600V(contact) , ±800v(air), RS=330Ω CS=150pF 10 times	—

Note1: No dew condensation to be observed.

Note2: The function test shall be conducted after 4 hours storage at the normal Temperature and humidity after remove from the test chamber.

Note3: The packing have to including into the vibration testing.

CONTOUR DRAWING

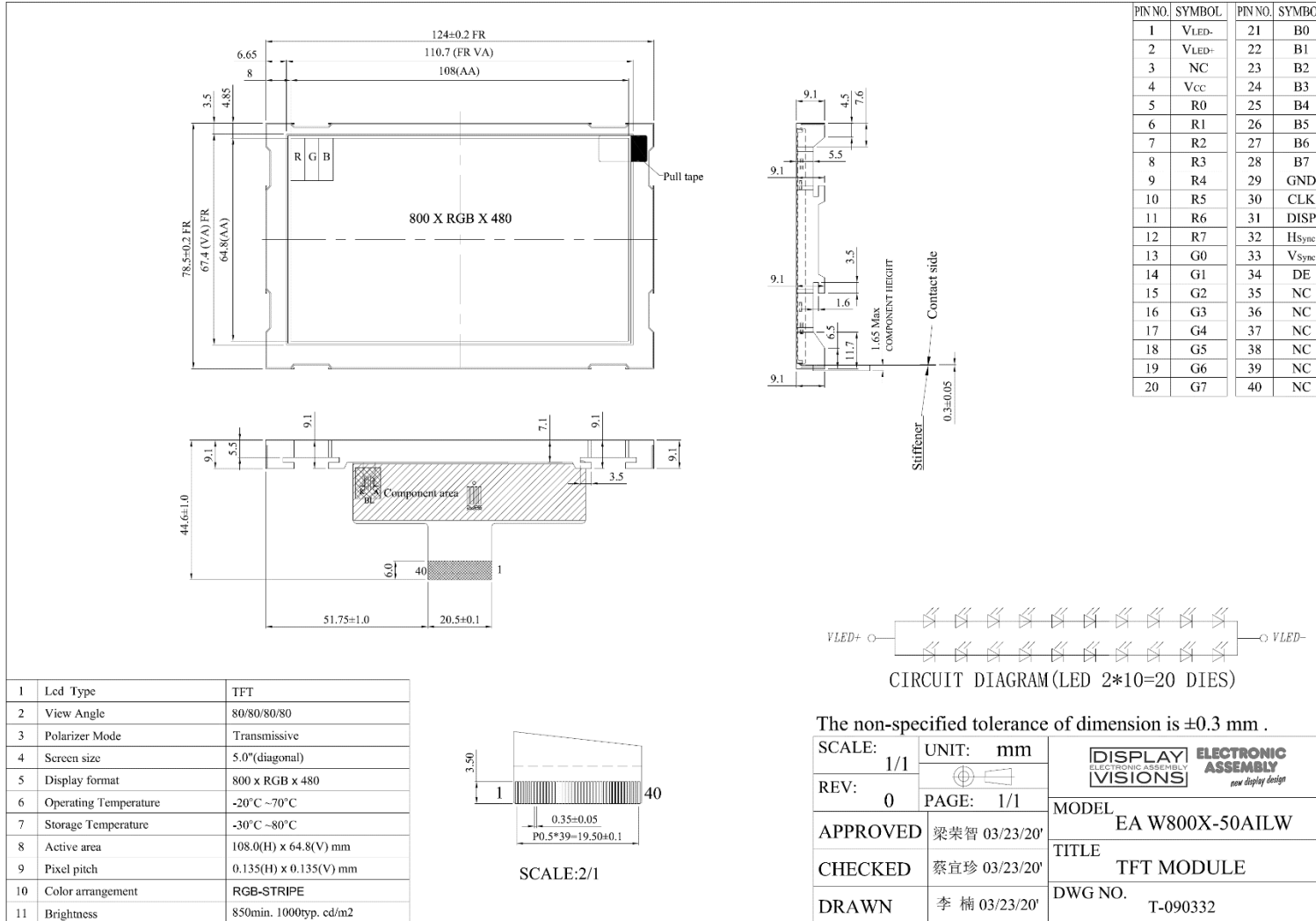

CAPACITIVE TOUCH

The EA TOUCH800-50C1 is a Projected Capacitive Touchpanel (PCAP). With its resolution of 800x480 it matches perfectly to the display incl. mounting frame EA W800X-50AILW.

Surface is glass with 6H hardness incl. anti-finger-print coating.

There's a controller FT5346 integrated that provides an I²C bus interface (address 0x70/0x71). It is good for up to 5 finger action and provides direct coordinates.

Outside of viewing area is a black cover printing. On the rear side is a double side adhesive glue for mounting abilities to display frame or frontal plate. It's preferred to use outer adhesive for front plate only and fixing the display by metal frame.

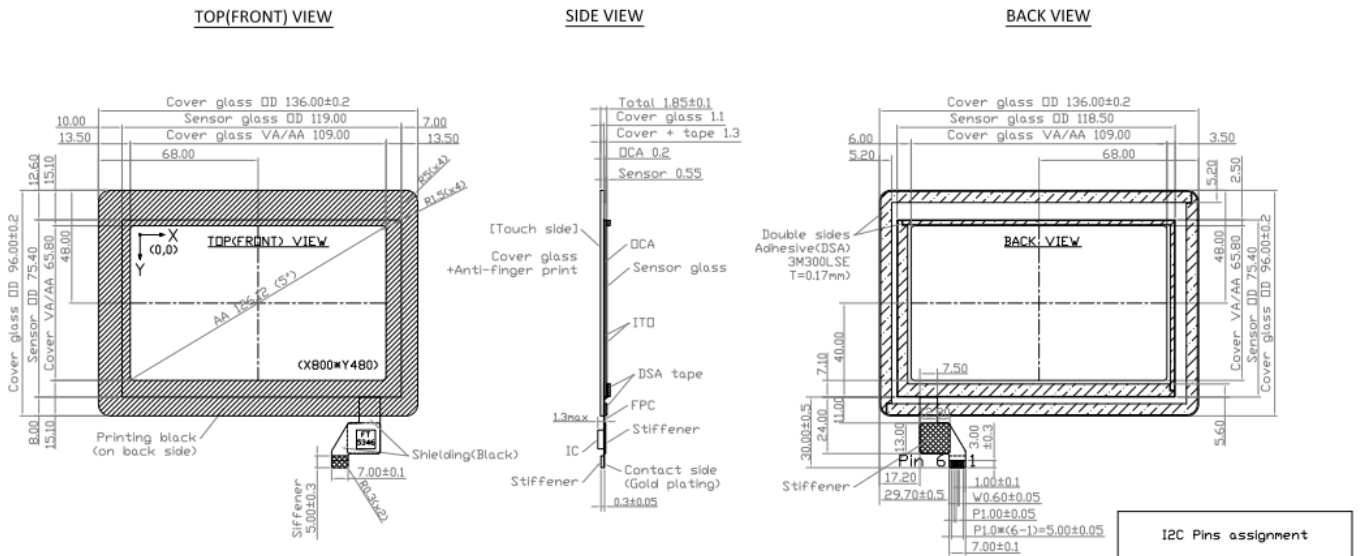

I2C Pins assignment	
Pin	IIC
1	SCL(3.3V)+Pullup (4.7KΩ)-VDD in FPC
2	SDA(3.3V)+Pullup (4.7KΩ)-VDD in FPC
3	VDD(3.3V)
4	RESET
5	INT
6	GND

Specifications:

1. 5" projected capacitive touch panel module;
2. Structure: cover glass + ITO glass;
3. 6H surface hardness; + Anti-Fingerprint
4. Touch controller FT5346; 5 fingers touch;
5. IIC interface; address:0x70; interrupt mode:pull low;
6. Operation voltage: 2.8-3.6V; I/O voltage:3.3V;
7. Resolution: 800x480;
8. Transparency >=87%;
9. RoHS compliance

TYPE: Projected Capacitive Touch Module		
UNIT: mm	SCALE: 1:1	SHEET: 1/1
GENERAL TOLERANCE: ±0.25		RoHS compliance
PROJECTION: 3rd Angle Projection		
APPROVAL:	DATE:	PRODUCT PN: ACT050A1
DRAW: T.Wang	DATE: 28 DEC 2015	CUSTOMER PN:



RESISTIVE TOUCH

The EA TOUCH800-50R1 is a 4 wire resistive touch panel. It has a selfadhesive material on its rear side that makes it simply to stuck onto the display frame. The connection is made by means of a 4-pin flexible cable for a ZIF connector (e.g. EA WF100-04S) with a grid of 1.0 mm. Bending radius is defined with min. 5mm. Interfacing to a μ C can be either done via external touch panel controller or directly with a μ C that is featured with analogue inputs. How to work with it ? The touch panel is similar to a potentiometer: connecting a voltage of e.g. 3.3V to the pins Top-Bottom makes it possible to read out a voltage on pin Left or Right which is linear to the Y-coordinate of the pressed point. The Xcoordinate will result when the voltage will be supplied to Left-Right and measurement is done at Top or Bottom. The pinout of the connecting cable is shown in the drawing.

2 Layers: Antiglare+antiscratch surface
incl. 0.1mm FOIL / GLAS adhesive glue
Thickness allover 1.5 (max.)

